

POTENZA ATTIVA circuitto trifase a 3 fili squilibrato

ACTIVE POWER unbalanced 3 wires three-phase circuit

MT-PA32

Il convertitore **ESAM MT-PA32** misura la potenza **attiva** di un circuito trifase a 3 fili (RST) simmetrico comunque squilibrato e fornisce in uscita una corrente continua (o una tensione) direttamente proporzionale alla potenza misurata e indipendente dal carico (**corrente impressa**).

Il sistema di misura realizza la classica inserzione **ARON**, al fine di ottenere la maggior precisione possibile in ogni condizione di utilizzo.

In opzione uscita seriale isolata **RS485** Modbus RTU (es. uscita analogica per protezione, uscita seriale per supervisione e controllo).

ESAM MT-PA32 transducer measures the **active** power of a symmetric however unbalanced 3 wires (RST) three-phase circuit and gives in output a **load-independent** direct current (or a voltage) directly proportional to the measured power.

The measuring system implements the classic **ARON** insertion, in order to obtain the best possible accuracy in every operating condition.

In option **RS485** Modbus RTU insulated serial output (e.g. analog output for fast feedback, serial output for supervision and control).

CARATTERISTICHE INGRESSO-USCITA (100% = P_n)

INPUT-OUTPUT CHARACTERISTICS (100% = P_n)

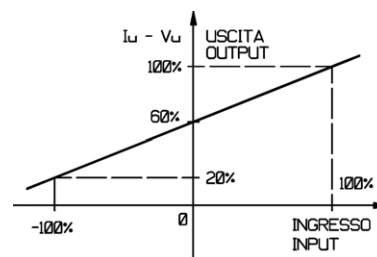
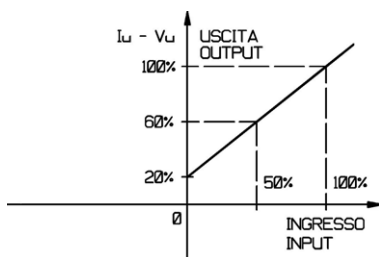
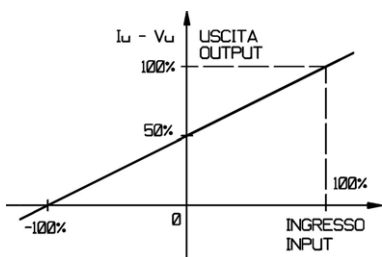
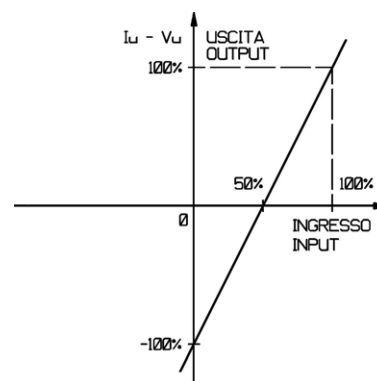
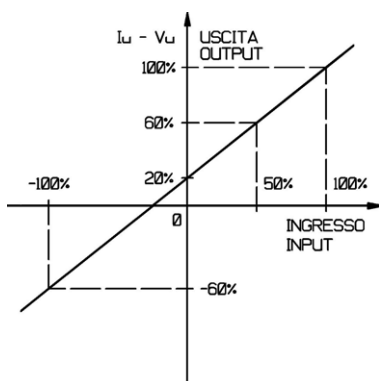
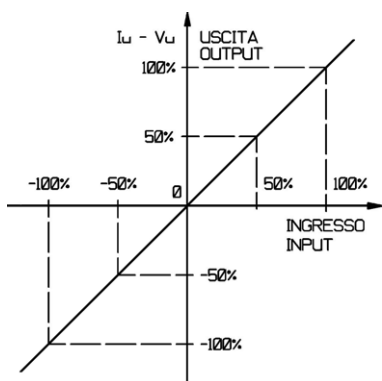

DIMENSIONI D'INGOMBRO OVERALL DIMENSIONS

SCHEMA D'INSERZIONE WIRING DIAGRAM

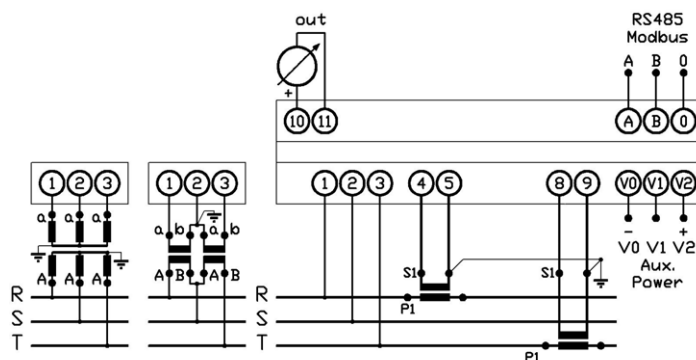
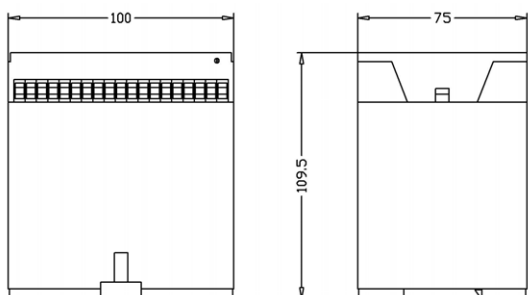

montaggio su profilato DIN EN 60715 TH 35 / DIN EN 60715 TH 35 rail mounting

modello model	MT-PA32				
grandezza misurata measured variable	potenza attiva active power				
inserzione insertion	circuito trifase a 3 fili squilibrato ARON ARON unbalanced 3 wires three-phase circuit				
versioni versions	autoalimentato / self-powered con alimentazione ausiliaria / with auxiliary power				
valori nominali di ingresso (Vn – In) input rated values	100V 220V 0,5A	100:√3V 220:√3V 1A	110V 380V 2,5A	110:√3V 500V 5A	
frequenza nominale / rated frequency (± 5% fn)	50Hz 60Hz				
campi di misura measuring ranges	0 ... Pn	- Pn ... 0 ... +Pn			
	Pn:	valore nominale potenza da misurare rated value of measured power			
campo di taratura calibration range	0,3 ... 1,2√3VnIn √3VnIn = Pn: valore nominale potenza da misurare (cosφ = 1) rated value of measured power (cosφ = 1)				
campo di variazione (V – I) variation range	0,8 ... 1,2Vn 0 ... 1,2Vn 0 ... 2In	autoalimentato / self-powered con alimentazione ausiliaria / with auxiliary power			
sovraccarico permanente / continuous overload	1,2Vn	2In			
sovraccarico istantaneo / instantaneous overload (1 sec)	2Vn 10In	(20In a richiesta / on request)			
grandezza in uscita (Iu – Vu) output variable	corrente continua impressa o tensione continua direct current (load-independent) or direct voltage				
campo della variabile d'uscita: 0 ... 1,2Iun (mA) 0 ... 1,2Vun (V) range of output variable	0 ... 1mA-V 0 ... ±1mA-V 1 ... 5mA-V 1...3...5mA-V	0 ... 5mA-V 0 ... ±5mA-V 2 ... 10mA-V 2...6...10mA-V	0 ... 10mA-V 0 ... ±10mA-V 4 ... 20mA 4...12...20mA	0 ... 20mA 0 ... ±20mA	
resistenza di carico (0 ... Rn) load resistance	0 ... 15V/Iun 0,1 ... 1MΩ (Vun)	(5mA: 3kΩ, 10mA: 1,5kΩ, 20mA: 0,75kΩ)			
uscita seriale (a richiesta) / serial output (on request)	RS485 protocollo MODBUS RTU / RS485 MODBUS RTU protocol				
precisione / accuracy	± 0,5% (± 0,2% a richiesta / on request)				
residuo di alternata / ripple	≤ 0,5%				
tempo di risposta / response time	≤ 250msec. (≤ 50msec. a richiesta / on request)				
alimentazione ausiliaria c.a. (±15%) a.c. auxiliary power	24V	100V	115V	230V	380V
alimentazione ausiliaria c.c. (±15%) d.c. auxiliary power	12V	24V	48V	110V	220V
autoconsumo consumption	ogni circuito voltmetrico / each voltmetric circuit: ≤ 1VA (Vn) ogni circuito amperometrico / each amperometric circuit: ≤ 0,8VA (In) alimentazione ausiliaria c.a. / a.c. auxiliary power: ≤ 4VA alimentazione ausiliaria c.c. / d.c. auxiliary power: ≤ 4W				
isolamento tra: / insulation between: ingressi – uscite / inputs – outputs ingressi – alim. ausiliaria c.a. / inputs – a.c. aux. power ingressi – alim. ausiliaria c.c. / inputs – d.c. aux. power uscite – alim. ausiliaria c.a. / outputs – a.c. aux. power uscite – alim. ausiliaria c.c. / outputs – d.c. aux. power uscita analogica – RS485 / analog output – RS485 tutti gli ingressi / all of inputs tutti i morsetti – massa / all of terminals – earth prova impulsivi / impulsive test	4kV / 60sec. 50Hz 4kV / 60sec. 50Hz 2kV / 60sec. 50Hz 4kV / 60sec. 50Hz 2kV / 60sec. 50Hz 1kV / 60sec. 50Hz 4kV / 60sec. 50Hz 4kV / 60sec. 50Hz 5kV 1,2μsec.				
peso / weight	Kg. 0,70				

ATTENZIONE TENSIONE PERICOLOSA Rischio di shock elettrico e ustioni. L'apparecchio deve essere installato da personale qualificato. Togliere tensione prima di eseguire ogni tipo di lavoro e osservare le istruzioni per l'uso. (per altre eventuali informazioni ved. www.esam.biz)
WARNING HAZARDOUS VOLTAGE Can cause electrical shock and burns. This equipment must be installed by qualified persons only. Disconnect power before proceeding with any work and observe the operating instructions (see www.esam.biz for other possible info).