

## COSφ, POTENZA ATTIVA E REATTIVA circuitto monofase

## COSφ, ACTIVE AND REACTIVE POWER single phase circuit

# MT-PFAR1

Il convertitore **ESAM MT-PFAR1** misura le potenze **attiva** e **reattiva** e calcola (ved. formula) il **cosφ** di un circuito monofase (F+N) e fornisce in uscita tre correnti continue (o tre tensioni) direttamente proporzionali alle potenze misurate e al **cosφ** indipendenti dal carico (**corrente impressa**).

**ESAM MT-PFAR1** transducer measures the **active** and **reactive** powers and calculates (see formula) the **cosφ** of a single phase circuit (F+N) and gives in output three **load-independent** direct currents (or three voltages) directly proportional to the measured powers and to the **cosφ**.

$$\cos \varphi = P / \sqrt{P^2 + Q^2}$$

$$\cos \varphi = P / \sqrt{P^2 + Q^2}$$

In opzione uscita seriale isolata **RS485** Modbus RTU (es. uscita analogica per protezione, uscita seriale per supervisione e controllo).

In option **RS485** Modbus RTU insulated serial output (e.g. analog output for fast feedback, serial output for supervision and control).

### CARATTERISTICHE INGRESSO-USCITA (100% = Pn, Qn, fondo scala campo cosφ scelto)

### INPUT-OUTPUT CHARACTERISTICS (100% = Pn, Qn, full scale selected cosφ range)

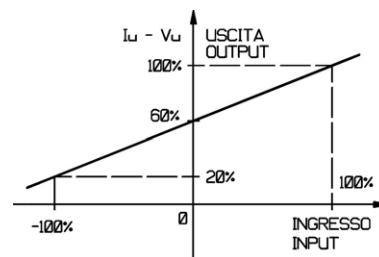
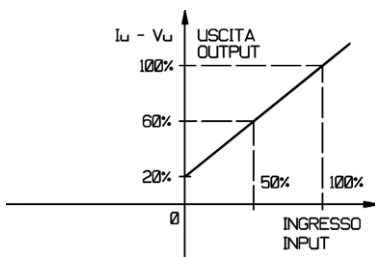
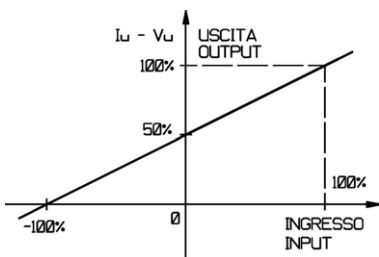
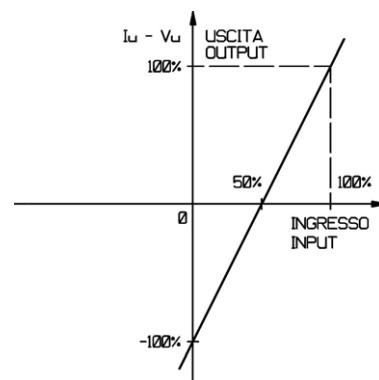
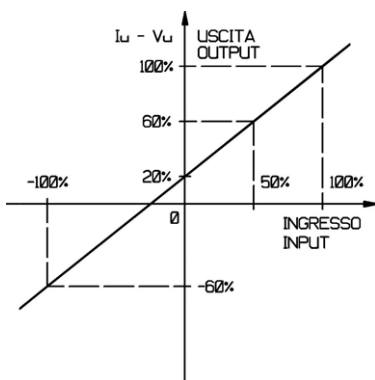
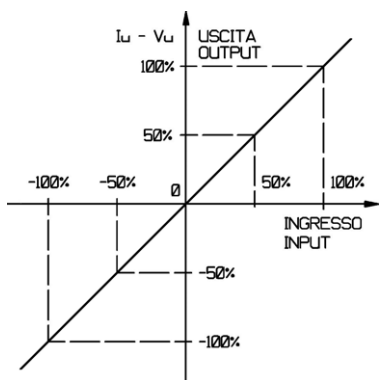

### DIMENSIONI D'INGOMBRO OVERALL DIMENSIONS

### SCHEMA D'INSERIZIONE WIRING DIAGRAM

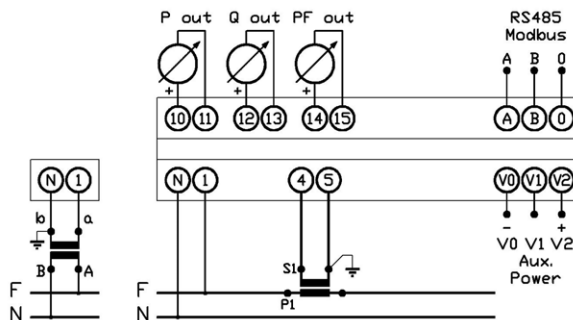
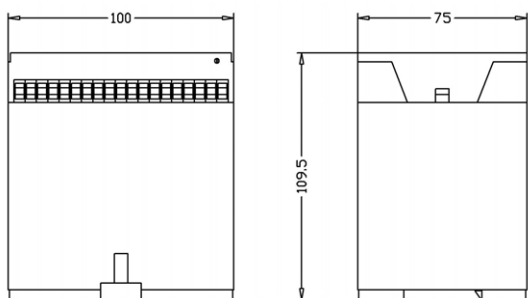

montaggio su profilato DIN EN 60715 TH 35 / DIN EN 60715 TH 35 rail mounting

modello model	MT-PFAR1				
grandezze misurate e calcolate <i>measured and calculated variables</i>	potenza attiva, reattiva e fattore di potenza (cosφ) <i>active power, reactive power and power factor (cosφ)</i>				
inserzione <i>insertion</i>	circuito monofase <i>single phase circuit</i>				
versioni <i>versions</i>	autoalimentato / <i>self-powered</i> con alimentazione ausiliaria / <i>with auxiliary power</i>				
valori nominali di ingresso (Vn – In) <i>input rated values</i>	100V 220V 0,5A	100:√3V 220:√3V 1A	110V 380V 2,5A	110:√3V 500V 5A	
frequenza nominale / <i>rated frequency (± 5% fn)</i>	50Hz 60Hz				
campi di misura <i>measuring ranger</i>	0 ... Pn - Pn ... 0 ... +Pn 0 ... Qn - Qn ... 0 ... +Qn cosφ: 0,5 capacitivo / <i>lead</i> ... 1 ... 0,5 induttivo / <i>lag</i> oppure / <i>or</i> cosφ: 0 capacitivo / <i>lead</i> ... 1 ... 0 induttivo / <i>lag</i> oppure / <i>or</i> cosφ: 0 ... 1 induttivo o capacitivo / <i>lag or lead</i>				
campo di taratura <i>calibration range</i>	0,3 ... 1,2VnIn VnIn = Pn, Qn: valore nominale potenza da misurare <i>rated value of measured power</i>				
campo di variazione (V – I) <i>variation range</i>	0,8 ... 1,2Vn autoalimentato / <i>self-powered</i> 0 ... 1,2Vn con alimentazione ausiliaria / <i>with auxiliary power</i> 0 ... 2In				
sovraccarico permanente / <i>continuous overload</i>	1,2Vn 2In				
sovraccarico istantaneo / <i>instantaneous overload (1 sec)</i>	2Vn 10In (20In a richiesta / <i>on request</i> )				
grandezza in uscita (Iu – Vu) <i>output variable</i>	corrente continua impressa o tensione continua <i>direct current (load-independent) or direct voltage</i>				
campo della variabile d'uscita: 0 ... 1,2Iun (mA) 0 ... 1,2Vun (V) <i>range of output variable</i>	0 ... 1mA-V 0 ... ±1mA-V 1 ... 5mA-V 1...3...5mA-V	0 ... 5mA-V 0 ... ±5mA-V 2 ... 10mA-V 2...6...10mA-V	0 ... 10mA-V 0 ... ±10mA-V 4 ... 20mA 4...12...20mA	0 ... 20mA 0 ... ±20mA	
resistenza di carico (0 ... Rn) <i>load resistance</i>	0 ... 15V/Iun (5mA: 3kΩ, 10mA: 1,5kΩ, 20mA: 0,75kΩ) 0,1 ... 1MΩ (Vun)				
uscita seriale (a richiesta) / <i>serial output (on request)</i>	RS485 protocollo MODBUS RTU / <i>RS485 MODBUS RTU protocol</i>				
precisione / <i>accuracy</i>	± 0,5% (± 0,2% a richiesta / <i>on request</i> )				
residuo di alternata / <i>ripple</i>	≤ 0,5%				
tempo di risposta / <i>response time</i>	≤ 250msec. (≤ 50msec. a richiesta / <i>on request</i> )				
alimentazione ausiliaria c.a. (±15%) <i>a.c. auxiliary power</i>	24V	100V	115V	230V	380V
alimentazione ausiliaria c.c. (±15%) <i>d.c. auxiliary power</i>	12V	24V	48V	110V	220V
autoconsumo <i>consumption</i>	circuito voltmetrico / <i>voltmetric circuit</i> : ≤ 1VA (Vn) circuito amperometrico / <i>amperometric circuit</i> : ≤ 0,8VA (In) alimentazione ausiliaria c.a. / <i>a.c. auxiliary power</i> : ≤ 4VA alimentazione ausiliaria c.c. / <i>d.c. auxiliary power</i> : ≤ 4W				
isolamento tra: / <i>insulation between:</i> ingressi – uscite / <i>inputs – outputs</i> ingressi – alim. ausiliaria c.a. / <i>inputs – a.c. aux. power</i> ingressi – alim. ausiliaria c.c. / <i>inputs – d.c. aux. power</i> uscite – alim. ausiliaria c.a. / <i>outputs – a.c. aux. power</i> uscite – alim. ausiliaria c.c. / <i>outputs – d.c. aux. power</i> uscite analogiche – RS485 / <i>analog outputs – RS485</i> tutti gli ingressi / <i>all of inputs</i> tutti i morsetti – massa / <i>all of terminals – earth</i> prova impulsi / <i>impulsive test</i>	4kV / 60sec. 50Hz 4kV / 60sec. 50Hz 2kV / 60sec. 50Hz 4kV / 60sec. 50Hz 2kV / 60sec. 50Hz 1kV / 60sec. 50Hz 4kV / 60sec. 50Hz 4kV / 60sec. 50Hz 5kV 1,2μsec.				
peso / <i>weight</i>	Kg. 0,70				

	<p><b>ATTENZIONE TENSIONE PERICOLOSA</b> Rischio di shock elettrico e ustioni. L'apparecchio deve essere installato da personale qualificato. Togliere tensione prima di eseguire ogni tipo di lavoro e osservare le istruzioni per l'uso. (per altre eventuali informazioni ved. <a href="http://www.esam.biz">www.esam.biz</a>)</p> <p><b>WARNING HAZARDOUS VOLTAGE</b> Can cause electrical shock and burns. This equipment must be installed by qualified persons only. Disconnect power before proceeding with any work and observe the operating instructions (see <a href="http://www.esam.biz">www.esam.biz</a> for other possible info).</p>
--	---