

COSφ, POTENZA ATTIVA E REATTIVA circuitto monofase

COSφ, ACTIVE AND REACTIVE POWER single phase circuit

MT-PFAR256

Il convertitore **ESAM MT-PFAR256** misura le potenze **attiva** e **reattiva** e calcola (ved. formula) il **cosφ** di un circuito monofase (F+N) e fornisce in uscita tre correnti continue (o tre tensioni) direttamente proporzionali alle potenze misurate e al cosφ indipendenti dal carico (**corrente impressa**).

$$\cos \varphi = P / \sqrt{P^2 + Q^2}$$

L'elevato campionamento di 256 punti / ciclo di rete garantisce una misura accurata anche con forme d'onda distorte e parzializzate

In opzione uscita seriale isolata **RS485** Modbus RTU (es. uscita analogica per protezione, uscita seriale per supervisione e controllo).

ESAM MT-PFAR256 transducer measures the **active** and **reactive** powers and calculates (see formula) the **cosφ** of a single phase circuit (F+N) and gives in output three **load-independent** direct currents (or three voltages) directly proportional to the measured powers and to the cosφ.

$$\cos \varphi = P / \sqrt{P^2 + Q^2}$$

The high sampling rate of 256 samples / mains cycle provides an accurate measurement even with distorted and phase-controlled waveforms.

In option **RS485** Modbus RTU insulated serial output (e.g. analog output for fast feedback, serial output for supervision and control).

CARATTERISTICHE INGRESSO-USCITA (100% = Pn, Qn, fondo scala campo cosφ scelto)

INPUT-OUTPUT CHARACTERISTICS (100% = Pn, Qn, full scale selected cosφ range)

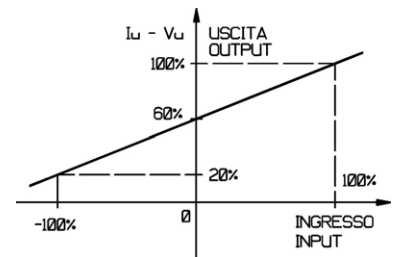
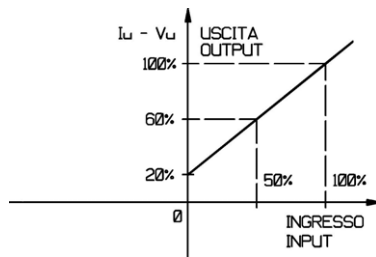
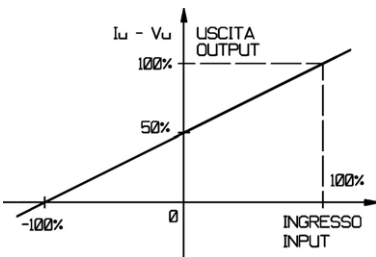
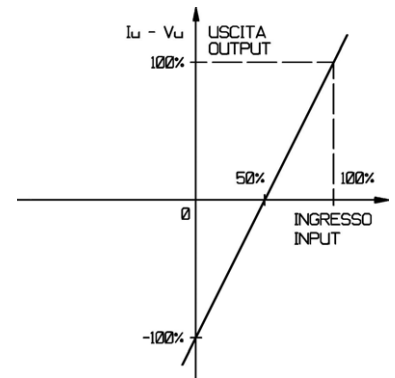
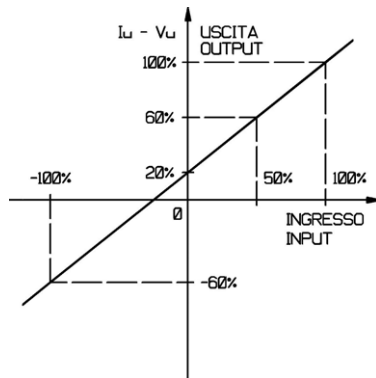
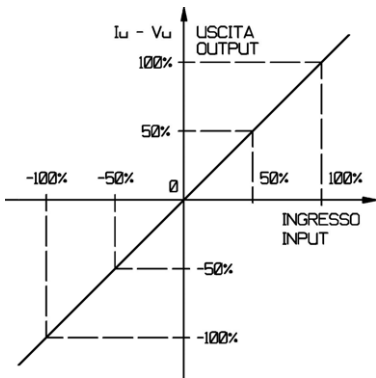

DIMENSIONI D'INGOMBRO OVERALL DIMENSIONS

SCHEMA D'INSERIZIONE WIRING DIAGRAM

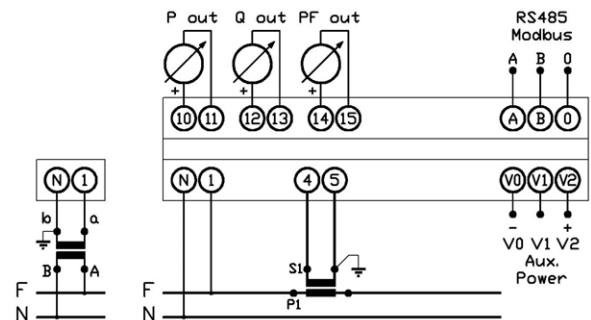
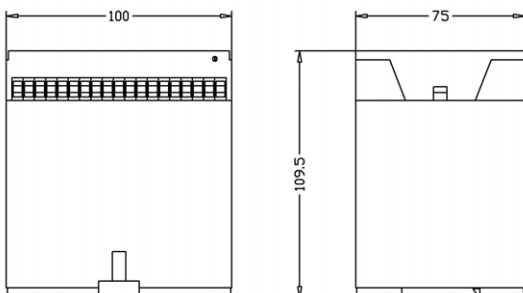

montaggio su profilato DIN EN 60715 TH 35 / DIN EN 60715 TH 35 rail mounting

modello model	MT-PFAR256				
grandezze misurate e calcolate <i>measured and calculated variables</i>	potenza attiva, reattiva e fattore di potenza (cosφ) <i>active power, reactive power and power factor (cosφ)</i>				
inserzione <i>insertion</i>	circuito monofase <i>single phase circuit</i>				
versioni <i>versions</i>	autoalimentato / <i>self-powered</i> con alimentazione ausiliaria / <i>with auxiliary power</i>				
valori nominali di ingresso (Vn – In) <i>input rated values</i>	100V 220V 0,5A	100:√3V 220:√3V 1A	110V 380V 2,5A	110:√3V 500V 5A	
frequenza nominale / <i>rated frequency (± 5% fn)</i>	50Hz 60Hz				
campi di misura <i>measuring ranger</i>	0 ... Pn - Pn ... 0 ... +Pn 0 ... Qn - Qn ... 0 ... +Qn cosφ: 0,5 capacitivo / <i>lead</i> ... 1 ... 0,5 induttivo / <i>lag</i> oppure / <i>or</i> cosφ: 0 capacitivo / <i>lead</i> ... 1 ... 0 induttivo / <i>lag</i> oppure / <i>or</i> cosφ: 0 ... 1 induttivo o capacitivo / <i>lag or lead</i>				
campo di taratura <i>calibration range</i>	0,3 ... 1,2VIn VnIn = Pn, Qn: valore nominale potenza da misurare <i>rated value of measured power</i>				
campo di variazione (V – I) <i>variation range</i>	0,8 ... 1,2Vn autoalimentato / <i>self-powered</i> 0 ... 1,2Vn con alimentazione ausiliaria / <i>with auxiliary power</i> 0 ... 2In				
sovraccarico permanente / <i>continuous overload</i>	1,2Vn 2In				
sovraccarico istantaneo / <i>instantaneous overload (1 sec)</i>	2Vn 10In (20In a richiesta / <i>on request</i>)				
grandezza in uscita (Iu – Vu) <i>output variable</i>	corrente continua impressa o tensione continua <i>direct current (load-independent) or direct voltage</i>				
campo della variabile d'uscita: <i>range of output variable</i>	0 ... 1mA-V 0 ... 5mA-V 0 ... 10mA-V 0 ... 20mA 0 ... ±1mA-V 0 ... ±5mA-V 0 ... ±10mA-V 0 ... ±20mA 1 ... 5mA-V 2 ... 10mA-V 4 ... 20mA 1...3...5mA-V 2...6...10mA-V 4...12...20mA				
resistenza di carico (0 ... Rn) <i>load resistance</i>	0 ... 15V/Iun (5mA: 3kΩ, 10mA: 1,5kΩ, 20mA: 0,75kΩ) 0,1 ... 1MΩ (Vun)				
uscita seriale (a richiesta) / <i>serial output (on request)</i>	RS485 protocollo MODBUS RTU / <i>RS485 MODBUS RTU protocol</i>				
precisione / <i>accuracy</i>	± 0,5% (± 0,2% a richiesta / <i>on request</i>)				
residuo di alternata / <i>ripple</i>	≤ 0,5%				
tempo di risposta / <i>response time</i>	≤ 250msec. (≤ 100msec. a richiesta / <i>on request</i>)				
alimentazione ausiliaria c.a. (±15%) <i>a.c. auxiliary power</i>	24V	100V	115V	230V	380V
alimentazione ausiliaria c.c. (±15%) <i>d.c. auxiliary power</i>	12V	24V	48V	110V	220V
autoconsumo <i>consumption</i>	circuito voltmetrico / <i>voltmetric circuit</i> : ≤ 1VA (Vn) circuito amperometrico / <i>amperometric circuit</i> : ≤ 0,8VA (In) alimentazione ausiliaria c.a. / <i>a.c. auxiliary power</i> : ≤ 4VA alimentazione ausiliaria c.c. / <i>d.c. auxiliary power</i> : ≤ 4W				
isolamento tra: / <i>insulation between:</i> ingressi – uscite / <i>inputs – outputs</i> ingressi – alim. ausiliaria c.a. / <i>inputs – a.c. aux. power</i> ingressi – alim. ausiliaria c.c. / <i>inputs – d.c. aux. power</i> uscite – alim. ausiliaria c.a. / <i>outputs – a.c. aux. power</i> uscite – alim. ausiliaria c.c. / <i>outputs – d.c. aux. power</i> uscite analogiche – RS485 / <i>analog outputs – RS485</i> tutti gli ingressi / <i>all of inputs</i> tutti i morsetti – massa / <i>all of terminals – earth</i> prova impulsi / <i>impulsive test</i>	4kV / 60sec. 50Hz 4kV / 60sec. 50Hz 2kV / 60sec. 50Hz 4kV / 60sec. 50Hz 2kV / 60sec. 50Hz 1kV / 60sec. 50Hz 4kV / 60sec. 50Hz 4kV / 60sec. 50Hz 5kV 1,2μsec.				
peso / <i>weight</i>	Kg. 0,70				



ATTENZIONE TENSIONE PERICOLOSA Rischio di shock elettrico e ustioni. L'apparecchio deve essere installato da personale qualificato. Togliere tensione prima di eseguire ogni tipo di lavoro e osservare le istruzioni per l'uso. (per altre eventuali informazioni ved. www.esam.biz)
WARNING HAZARDOUS VOLTAGE Can cause electrical shock and burns. This equipment must be installed by qualified persons only.
 Disconnect power before proceeding with any work and observe the operating instructions (see www.esam.biz for other possible info).